

ELECTRICAL CONNECTION ELEMENTS

Main Power Connector - connects electrically conductive contact strips to power supply.

Corner Power Connector - connects electrically conductive contact strips in profile corners.

Straight Power Connector - connects electrically conductive contact strips in direct connection.

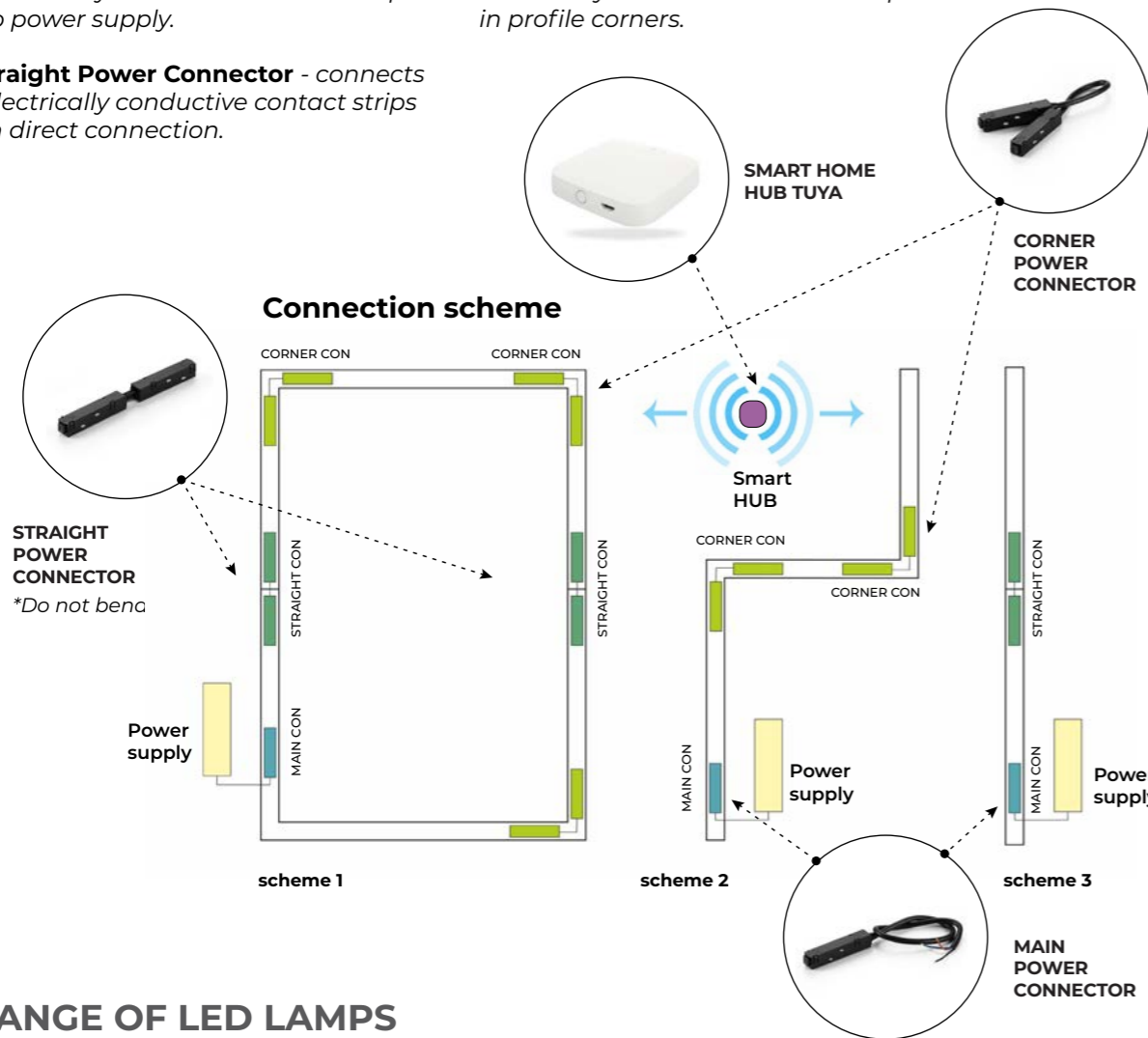

RANGE OF LED LAMPS



A range of stylish decorative LED luminaires of different shapes and purposes has been developed for this system. There are directional, swivel, shadow, pendant, etc. about 40 types. All directional luminaires are equipped with antiglare system, which more comfortable for eyes. Please contact with your regional manager for information about LED lamps.

The luminaires are controlled by a mobile phone or special panels via a smart home system. Each luminaire can be controlled individually or in a group.

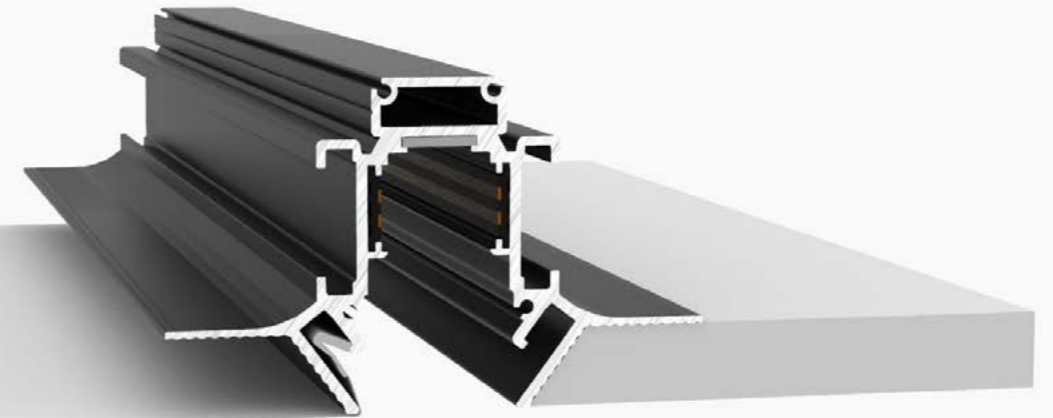

AL 41 Easy Light G2

Used with MINI harpoon

AL 41 Easy Light G2 profile is a new generation product that retains all the functions of the previous version AL 35 Easy Light, but with its own distinctive features. This profile belongs to the **patented VECTA Easy Light system** and offers the same possibility to easily adjust the position of luminaires, control the direction of the light beam and smoothly adjust the brightness.

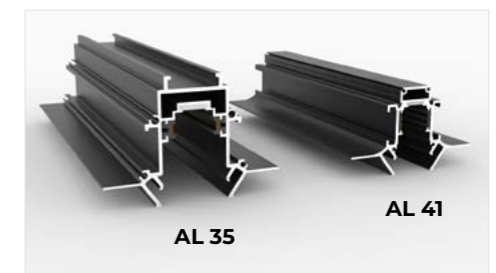

Easy Light system profiles for comparison

Key Features:

- Designed for a power consumption of 48V.
- Has its own LED Luminaire collection.
- Control of the LED Luminaires is facilitated via Smart Home System by a Mobile phone or a Smart panel, allowing various possibilities of individual or group management of the luminaires.
- Magnetic luminaire mounting with simple plug&slide system.
- Easily change the position of the luminaires to suit your mood.
- The profile can be used in conjunction with stretch ceilings or other ceiling materials such as plasterboard, allowing different materials to be combined in the same space.

AL 41 Easy Light G2 in Interior



PROFILE REAL-SIZE DIMENSIONS

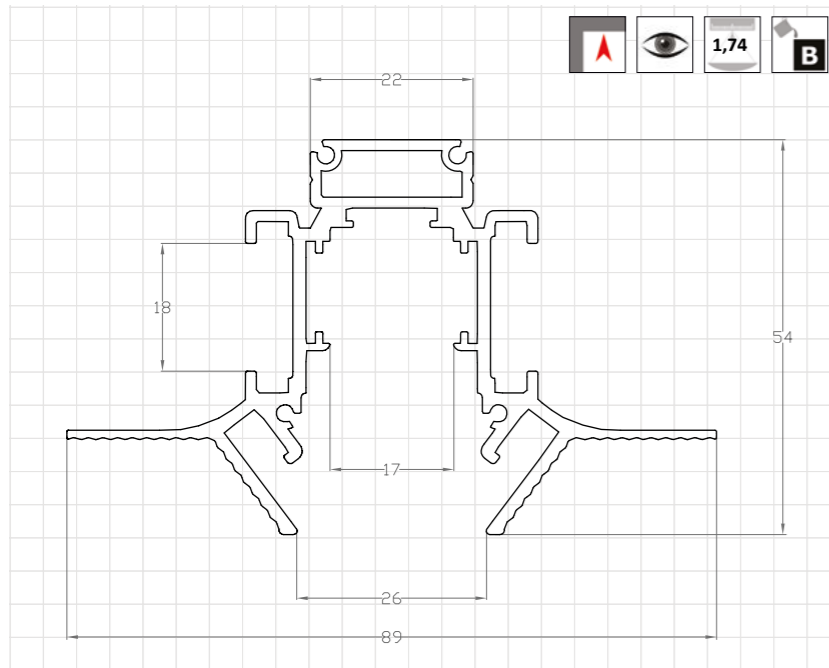

DESCRIPTION

The profile structure is provided with four screw slots on its side, providing a simple method of fixing the CAP 41 end cover. The side slots allow the profile to be joined along its length, facilitating the creation of structures with different lengths.

The upper hollow section is specifically designed for mounting the profile to the primary ceiling using the Vecta Support system. In the lower part of the profile, there are recesses for the attachment of tensioning harpoons. In addition, there are edge strips on both outer sides for fixing alternative ceiling materials, for example plasterboard.

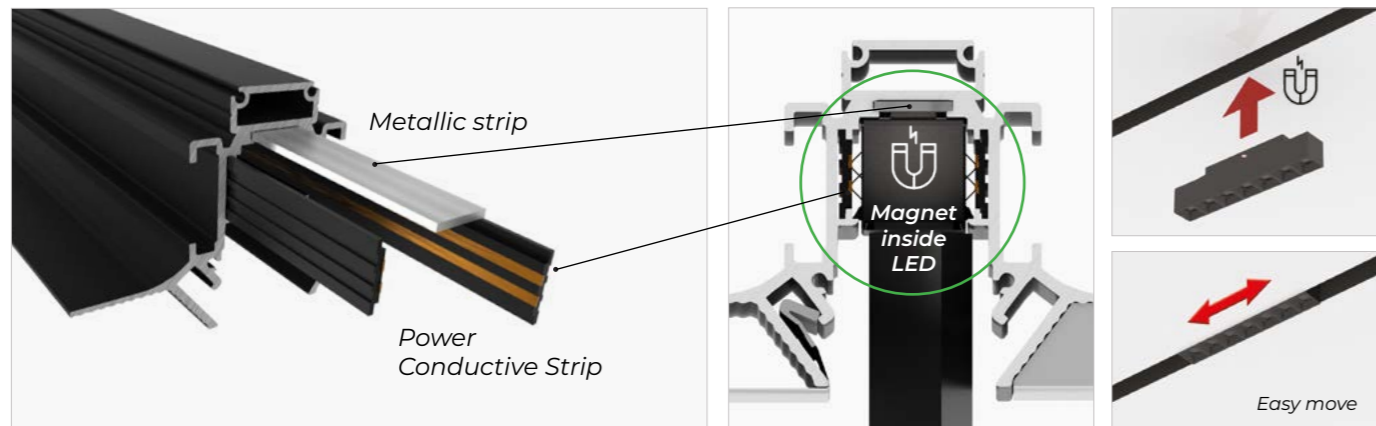

The profile is equipped with electrically conductive elements and a metal strip. The luminaires for this system are equipped with magnets, they are securely magnetised to the profile and can be easily moved to a convenient position according to the changing lighting needs of the room.

There are two ways to change the location of the lamp: slide the lamp along the profile or pull the lamp out and place it to the new position.

CONNECTION ELEMENTS



LC 08
for side profile connection



LC 10
for outside or inside corner connection



EASY LIGHT SYSTEM WITH AL 41

Profile AL 41 is suitable to use in any room, it will give also the possibility to combine different materials in the same room.

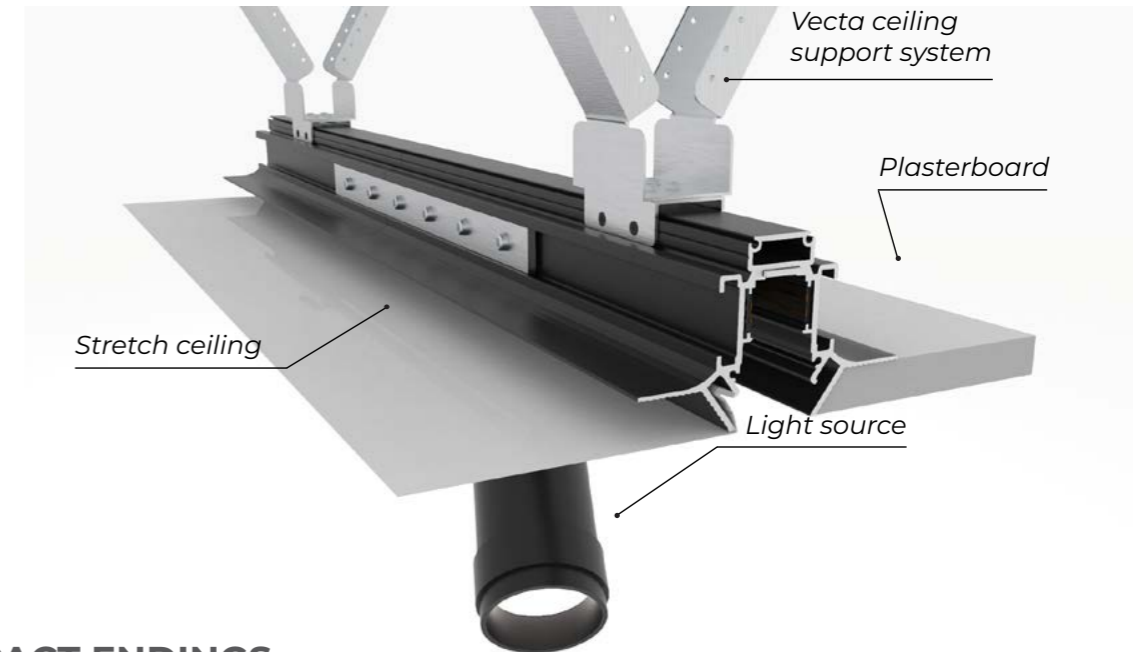

COMPACT ENDINGS

There are two types of end caps for this system: the **CAP 41** profile cover and the **CAP 41 A** wall adapter.

CAP 41 is used to close the ends of the profile in 'independent positioning'.

When mounting the profile to the wall, it is recommended to use the **CAP 41 A** adapter. This adapter is designed to be used in combination with the **AL 05** profile to facilitate the installation of the stretch ceiling in the 'profile to wall' construction.



CAP 41 is for covering profile ends

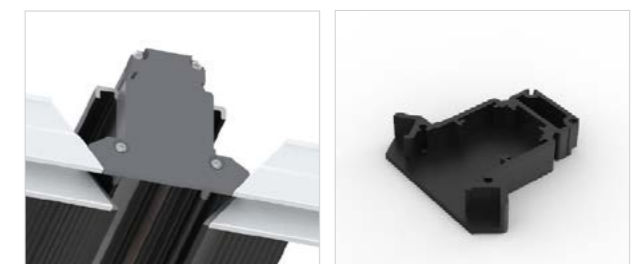

CAP 41 A suitable for connecting AL 05 for wall mount

